



EDEN

balançoire 4 places avec
moustiquaire / 4 seaters
glider swing with sliding
net



3570

23

service@durahousewares.com

1-888-288-3872

To ease assembly for this item, please call Service at (1-888)288-3872 or e-mail us at service@durahousewares.com we will link you to assembly video .

Pour faciliter l'assemblage de ce produit veuillez appeler au 1-888-288-3872

ou par courriel service@durahousewares.com, nous vous donnerons un lien pour le vidéo d'assemblage.

Avertissement

Pour protéger votre balançoire pendant l'hiver

- Retirez le toit et conservez-le au sec dans un endroit frais.
- Défaire la structure du toit de la balançoire et remiser dans un endroit sec.
- Couvrez le reste de votre balançoire avec une bâche imperméable attachée sous la base de la balançoire.

Ne pas suivre les indications ci-dessus entraînera des dommages irréparables à ce produit et fera s'effondrer la structure du toit.

Les toits effondrés ne sont pas couverts par la garantie.

Warning

To protect your swing during winter

- . Remove the canopy and store dry in warm place
- . Must undo the canopy structure and store in dry place
- . Cover the rest of your swing with waterproof tarp tied under swing base.

Failing to do so will result in irreparable damage to this product and the collapse of the roof structure.

Collapsed roofs are not under warranty.

Avertissement

Ce produit est conçu pour un poids maximum de 225lbs, par siège. Ne pas dépasser ce poids.

Ne pas vous tenir debout sur ce produit.

Ce produit doit être utilisé uniquement sur le sol plat et ferme.

Assurez-vous que la base reste en contact avec le sol.

Gardez les pièces hors de la portée des enfants.

Vérifiez toutes les vis ou boulons s'ils sont bien serrés et inspecter régulièrement.

Ne pas serrez les vis jusqu'à ce que le produit soit entièrement assemblée.

Ne serrez pas trop les vis ou boulons.

N' utilisez pas ce produit si des pièces sont manquantes, endommagées ou usées.

Ce produit a été conçu pour être utilisé par une personne chaque siège à la fois.

Note

Les BEARINGS (pièces N) à une garantie de 30 jours à partir de la date d'achat.

Si à l'avenir vous avez besoin de remplacement, vous pouvez communiquer avec nous, ils sont disponibles à la vente dans nos entrepôts

Avant de commencer

Déballez tous les matériaux fournis.

Vérifiez le paquet et assurez —vous d'avoir toutes les pièces énumérées ci-dessus.

S'il manque des pièces, si vous avez des questions,

SVP communiquer avec nous au Tel: 1-888-288-3872 entre 9:am —4: pm

Courriel: service@durahousewares.com

Les instructions d'entretien

Pour nettoyer la chaise, essuyez avec de l'eau chaude et savonneuse à l'aide d'une éponge, ensuite essuyer avec un chiffon sec et propre.

Ne pas utiliser des produits nettoyants javellisants ou à base de détergent car ils peuvent endommager le produit.

Ne jamais utiliser un tuyau de pression pour nettoyer ce produit.

Ne jamais utiliser d'éponges métalliques, abrasifs ou de nettoyant chimiques.

Ranger le produit dans un endroit sec, avant de le ranger, s'assurer qu'il est propre et sec.

Durant l'hivers et les mauvaises conditions météorologiques, le produit devrait être entreposé dans un endroit sec.

NE PAS RETOURNER AU MAGASIN

Warnings

This product is intended for a maximum weight of 225 lbs, per seat. Do not exceed this weight.

Do not stand on the product.

This product should only be used on firm, level ground.

Make sure the frame remains in contact with the ground.

Keep small parts out of reach of children.

Check all screws or bolts are tightened and inspect regularly.

Do not tighten screws until fully assembled.

Do not overtighten screws or bolts.

Do not use this product if parts are missing, damaged or worn.

This product has been designed for use by one person per seat at the time.

Note

The BEARINGS(part N) has a 30 day warranty from the date of purchase.

If in the future you need a replacement, you can contact us,

they are available for sale in our warehouses.

Before you Start

Unwrap all packaging materials.

Check the pack and make sure you have all of the parts list above.

If you are missing pieces or have any questions,

Please call us Tel: 1-888-288-3872 between 9:am -4:pm

Email : service@durahousewares.com

Care instructions

To clean wipe with a sponge and warm water then wipe with a dry clean cloth.

Do not use solvent cleaners or detergents as they can bleach or damage the product.

Never use a pressure hose or washer to clean product.

Never use scourers, abrasives or chemical cleaners.

Wipe clean with a soft dry cloth.

Store the product in a dry place. Before storage make sure that the product is clean and dry.

During bad weather and winter months the product should be stored in a dry place.

DO NOT RETURN TO STORE

ITEM #3570















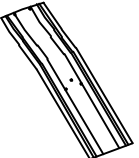
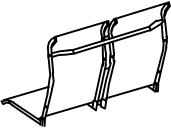

Eden Swing / Balançoire Eden

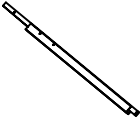
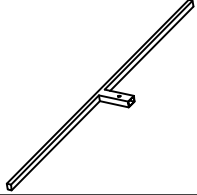

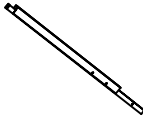
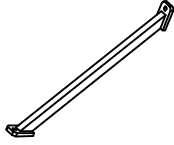



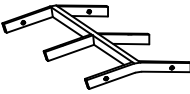





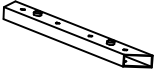





Instructions générales

1. Avant de commencer l'assemblage, comptez et vérifiez la liste des pièces afin de s'assurer que toutes les pièces sont dans la boîte.
2. Cette structure devrait être montée sur un terrain plat.
3. Conservez ces instructions pour référence future.
4. Ne pas serrer les vis jusqu'à ce que la structure soit entièrement assemblée.
5. Ne pas retourner au vendeur. Au cas où vous avez besoin de pièces ou de l'aide, appelez-nous du lundi au vendredi de 9:00 à 16:00 au (1-888) 288-3872 ou par courriel à service@durahousewares.com
6. S'il vous plaît, suivez les instructions étape par étape et vous n'aurez pas de problème de montage.
7. Des soins adéquats vous donneront plusieurs années d'utilisation de ce produit.
8. Si vous avez des pièces endommagées et que vous avez besoin de remplacement, s'il vous plaît envoyez des photos et preuve d'achat par courriel afin que nous puissions mieux vous servir.
9. Ce toit n'est pas conçu pour résister au poids de la neige. Il est donc important d'enlever la structure du toit (les panneaux en polycarbonate ou tissu, et les barreaux métalliques) pour l'hiver.



General instructions.

1. Before you start the assembly, count and check the parts list to make sure that all parts are in the box.
2. This structure should be mounted on flat even ground.
3. Keep this instructions sheet for future reference.
4. Do not tighten screws until structure is fully assembled.
5. Do not return to vendor. In case you need parts or help, call us Monday to Friday from 9:00 am to 4:00 pm at (1-888) 288-3872 or email us at service@durahousewares.com
6. Please follow step by step instructions and you will not have any assembly problem.
7. Proper care will give you years of usage of this product.
8. If you have damaged parts and you need replacement please send pictures and receipt by email, so we can serve you better.
9. This roof is not designed to withstand the weight of snow, therefore it is very important to remove the roof structure (polycarbonate panels or canopy, and metal ribs) for the winter.

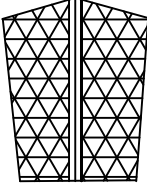
PART/PIECE	FIGURE/DESSIN	QTY/QTEE	PART/PIECE	FIGURE/DESSIN	QTY/QTEE	PART/PIECE	FIGURE/DESSIN	QTY/QTEE
A		1	G	 Ø18*Ø8*30	8	M		1
B		1	H	 Ø16*Ø8*20	4	N		2
C		2	I		58	O		1
D		4	J	 25*15*1330	2	P		2
E		2	J0	 25*15*1330	2	Q		2
E1		2	J1	 25*15*1300	2	R		2
F	 42*14*1100	4	K		1	S		1





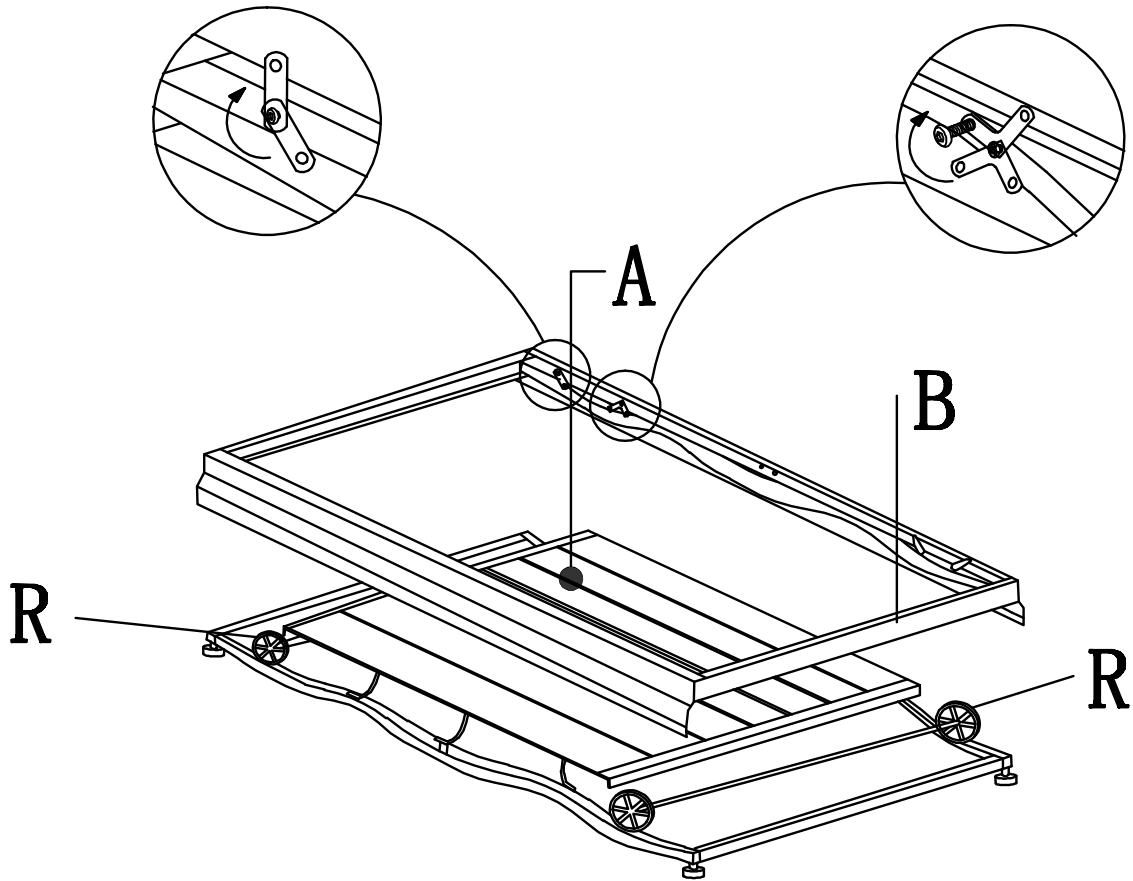

PART/PiECE	FIGURE/DESSIN	QTY/QTEE	PART/PiECE	FIGURE/DESSIN	QTY/QTEE	PART/PiECE	FIGURE/DESSIN	QTY/QTEE
T		4	Z5	 M6*40	8	Z11	 M6*35	4
U		2	Z6	 M6*35	12	V	 Ø12*Ø6.2X1.0	66
Z1	 M6*90	4	Z7	 M6*25	8	W	 M6	48
Z2	 M6*75	8	Z8	 M6*15	14	X		1
Z3	 M6*50	16	Z9	 M6*12 already assembled / deja assemble	12	Y		1
Z4	 M6*45	8	Z10	 M6*60	4	Y4	 already assembled / deja assemble	24
Y2		1	Y5		1			

1

PART/PTRCE	FIGURE/DESSIN	QTY/QTEE	PART/PTRCE	FIGURE/DESSIN	QTY/QTEE
A		1	B		1
R		2			



2

PART/PTRCE	FIGURE/DESSIN	QTY/QTEE	PART/PTRCE	FIGURE/DESSIN	QTY/QTEE
D		4	F	 42*14*1100	4
Z3	 M6*50	16	Z4	 M6*45	8
I		24	V	 Ø12*Ø8.2X1.0	8
W	 M6	8			

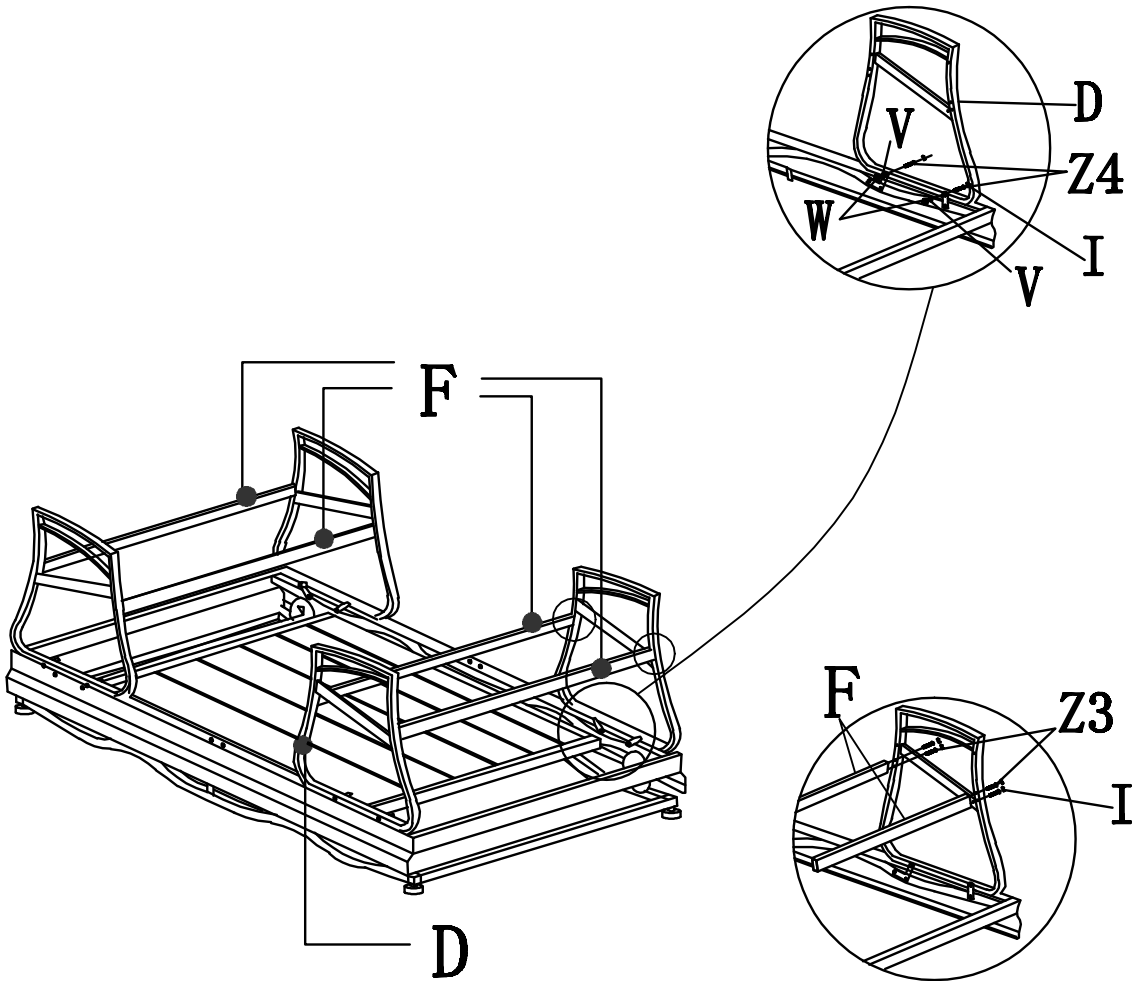

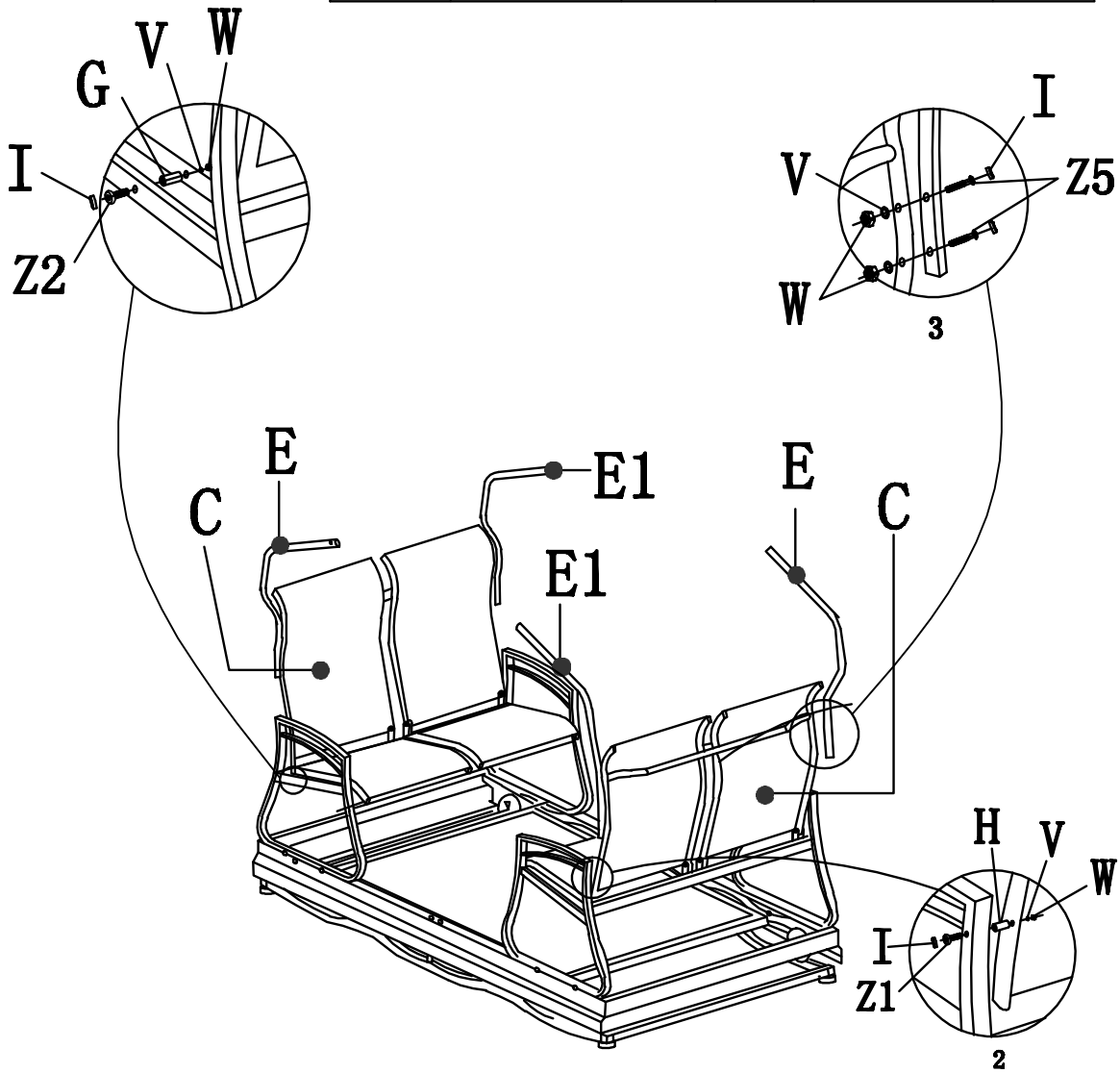

3

PART/PIECE	FIGURE/DESSIN	QTY/QTEE	PART/PIECE	FIGURE/DESSIN	QTY/QTEE
C		2	E		2
E1		2	Z1		4
Z2		8	Z5		8
G		8	H		4
I		20	V		20
W		20			







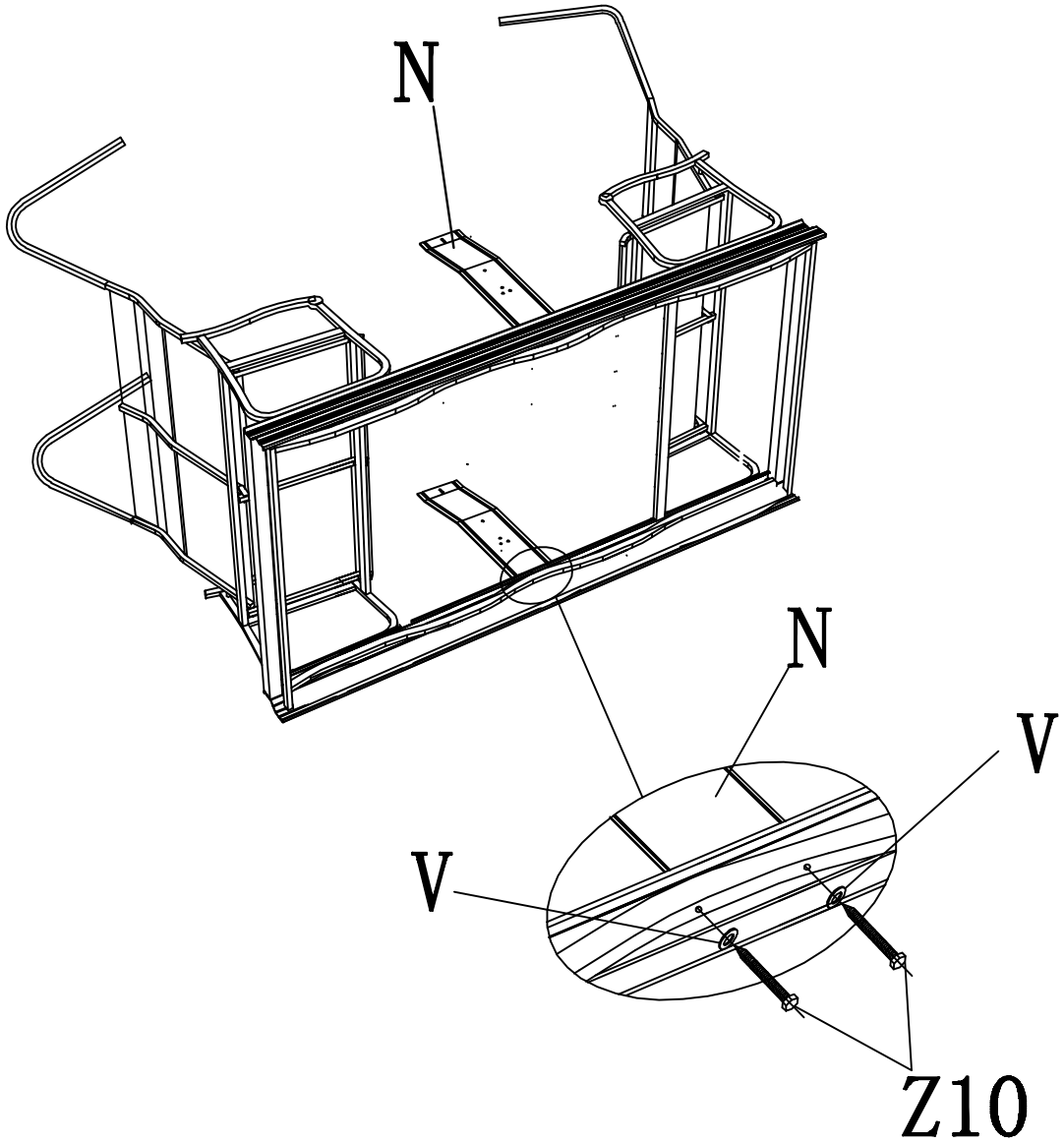

4

PART/PTECE	FIGURE/DESSIN	QTY/QTEE	PART/PTECE	FIGURE/DESSIN	QTY/QTEE
N		2	Z10	 M6*60	4
V	 Ø12*Ø8.2X1.0	4			





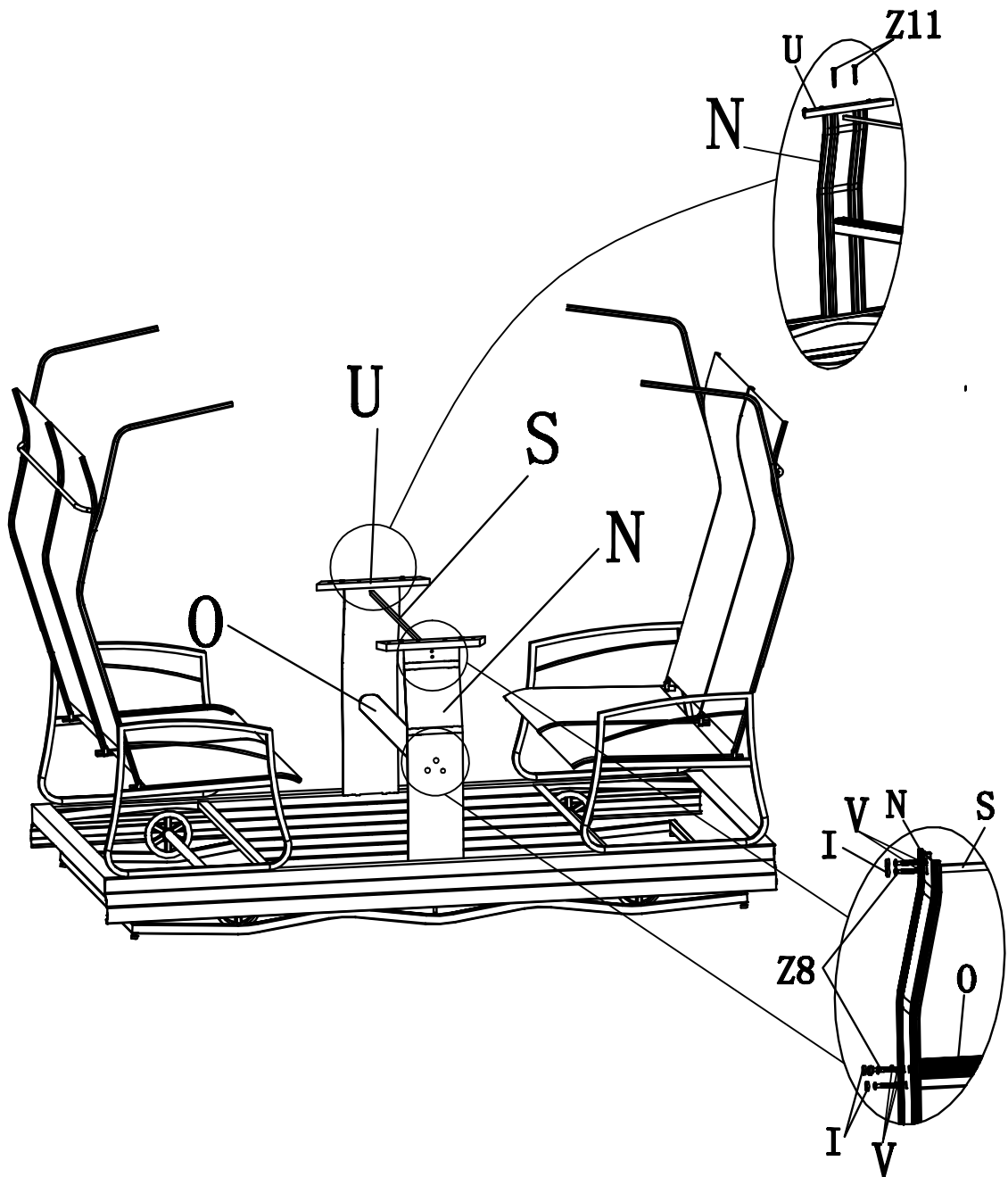

5

PART/PIECE	FIGURE/DESSIN	QTY/QTEE	PART/PIECE	FIGURE/DESSIN	QTY/QTEE
O		1	S		1
U		2	Z8	 M6*15	10
Z11	 M6*35	4	V	 Ø12*Ø6.2X1.0	10
I		10			



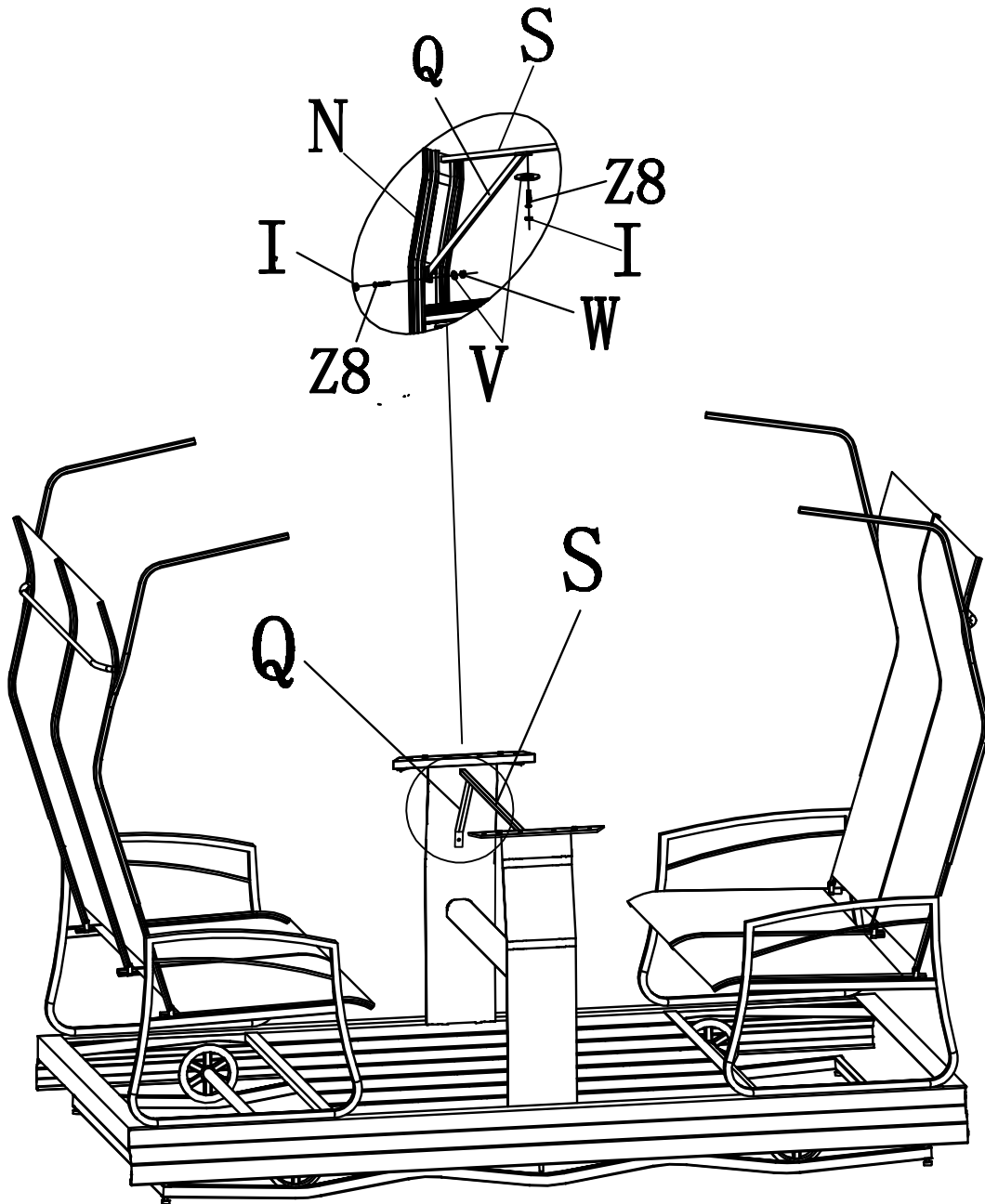

6

PART/PIECE	FIGURE/DESSIN	QTY/QTEE	PART/PIECE	FIGURE/DESSIN	QTY/QTEE
Q		2	Z8		4
W	 M6	2	V		4
I		4			



7



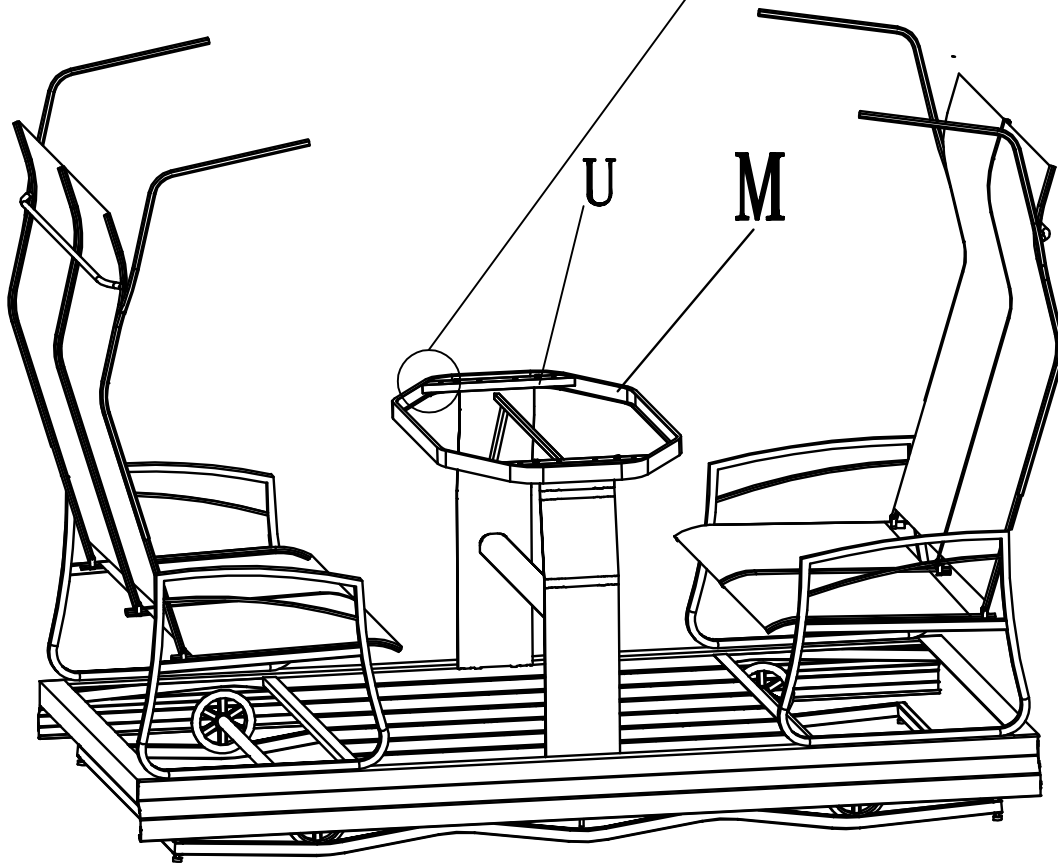
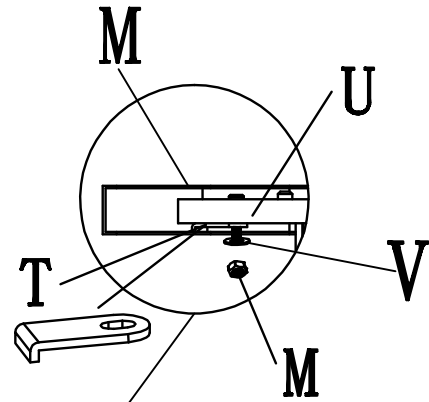

PART/PIECE	FIGURE/DESSIN	QTY/QTEE	PART/PIECE	FIGURE/DESSIN	QTY/QTEE
M		1	T		4

Loosen the screw on part T,
turn the hook and fasten the
hook to the table frame (part
M), tighten the screw.

Desserrer les vis de la
pièce T tourner le
crochet et fixer le
crochet au cadre de la
table (pièce m) serrer
les vis.





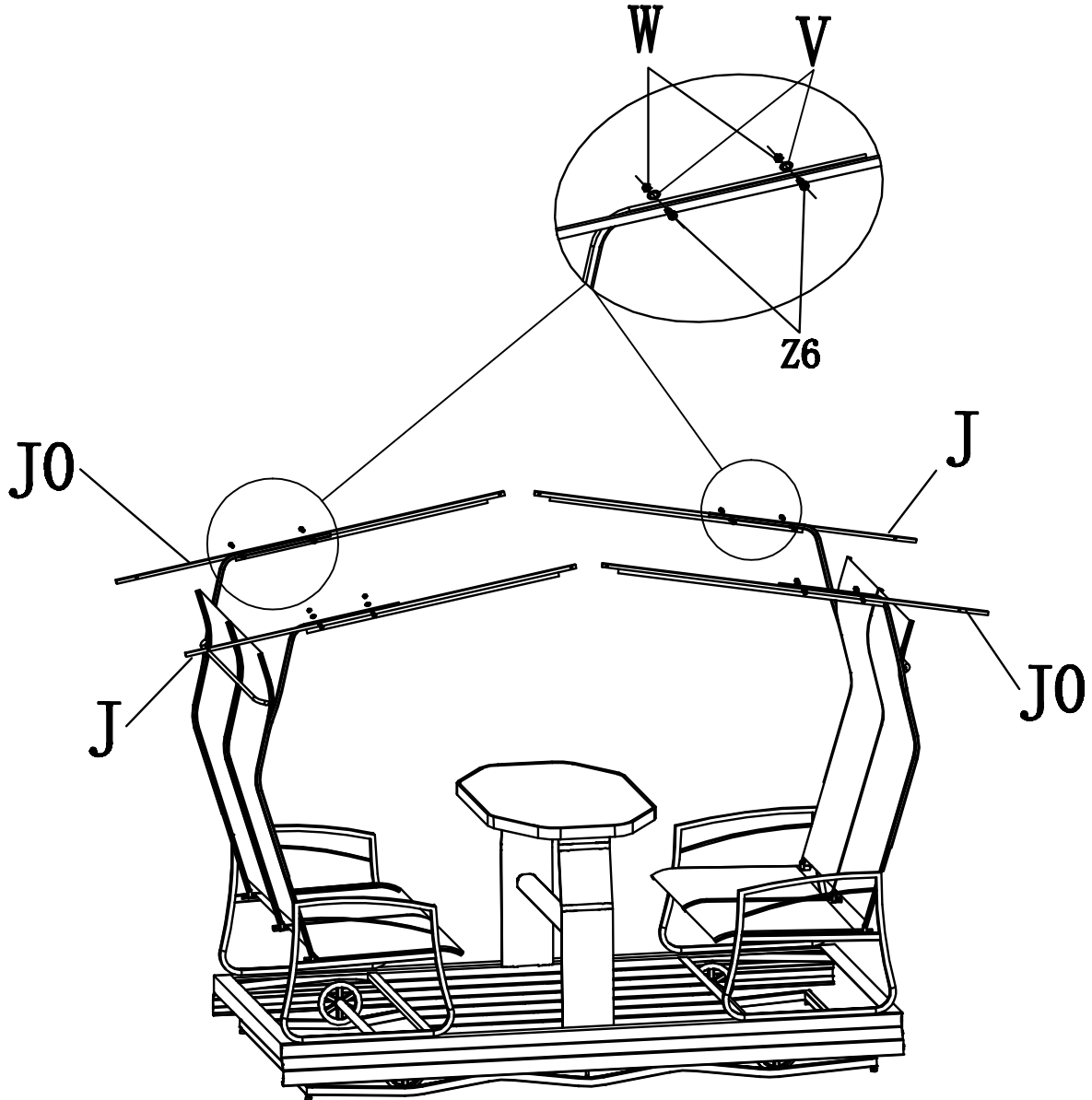

8

PART/PIECE	FIGURE/DESSIN	QTY/QTEE	PART/PIECE	FIGURE/DESSIN	QTY/QTEE
J0	 25*15*1330	4	J	 25*15*1330	4
Z6	 M6*35	8	W	 M6	8
V	 Ø12*Ø6.2X1.0	8			





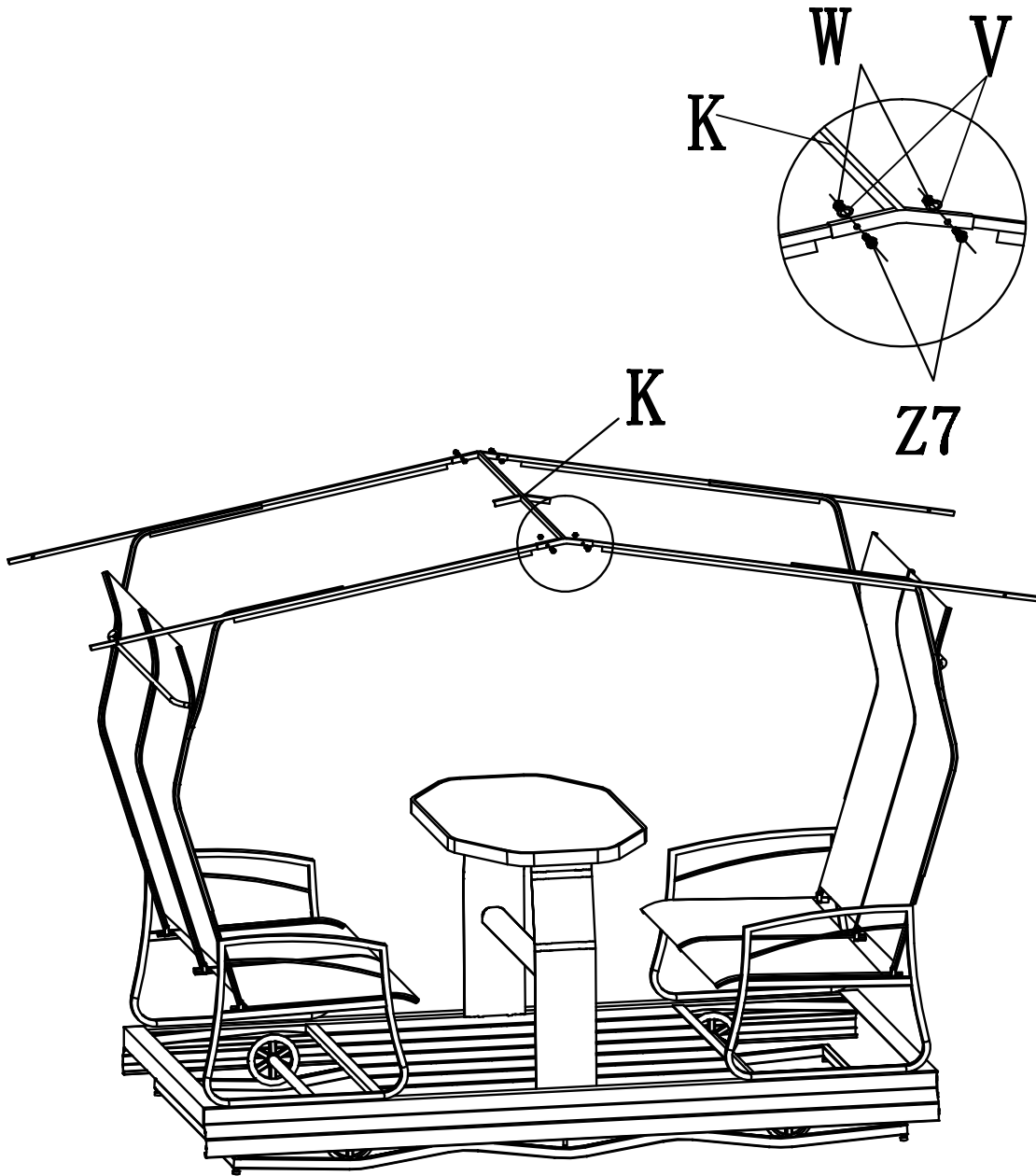

9

PART/PIECE	FIGURE/DESSIN	QTY/QTEE	PART/PIECE	FIGURE/DESSIN	QTY/QTEE
K		1	Z7	 M6*25	4
W	 M6	4	V	 Ø12*Ø6.2X1.0	4





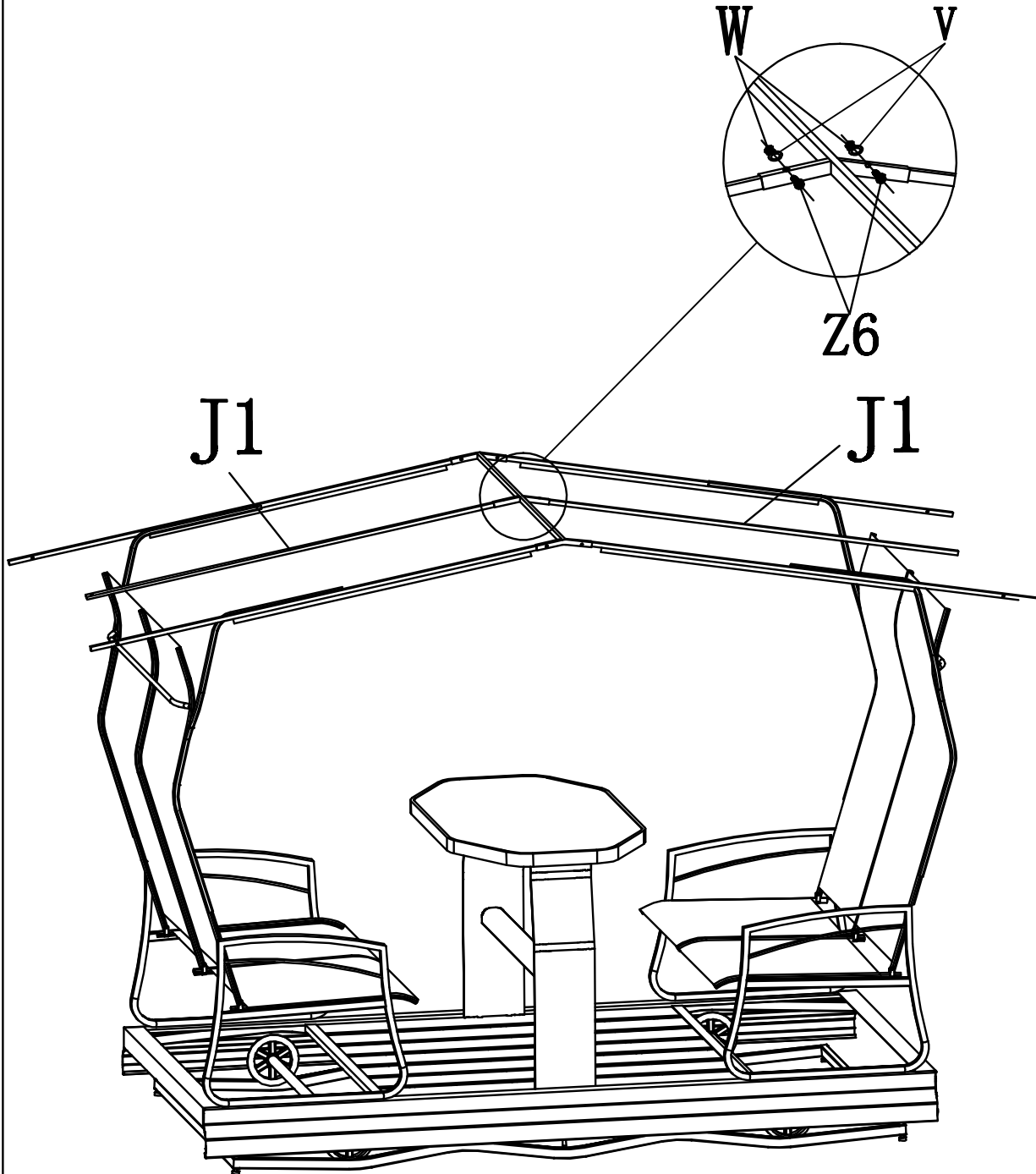

10

PART/PIECE	FIGURE/DESSIN	QTY/QTEE	PART/PIECE	FIGURE/DESSIN	QTY/QTEE
J1	 25*15*1300	2	Z6	 M6*35	2
W	 M6	2	V	 Ø12*Ø6.2X1.0	2



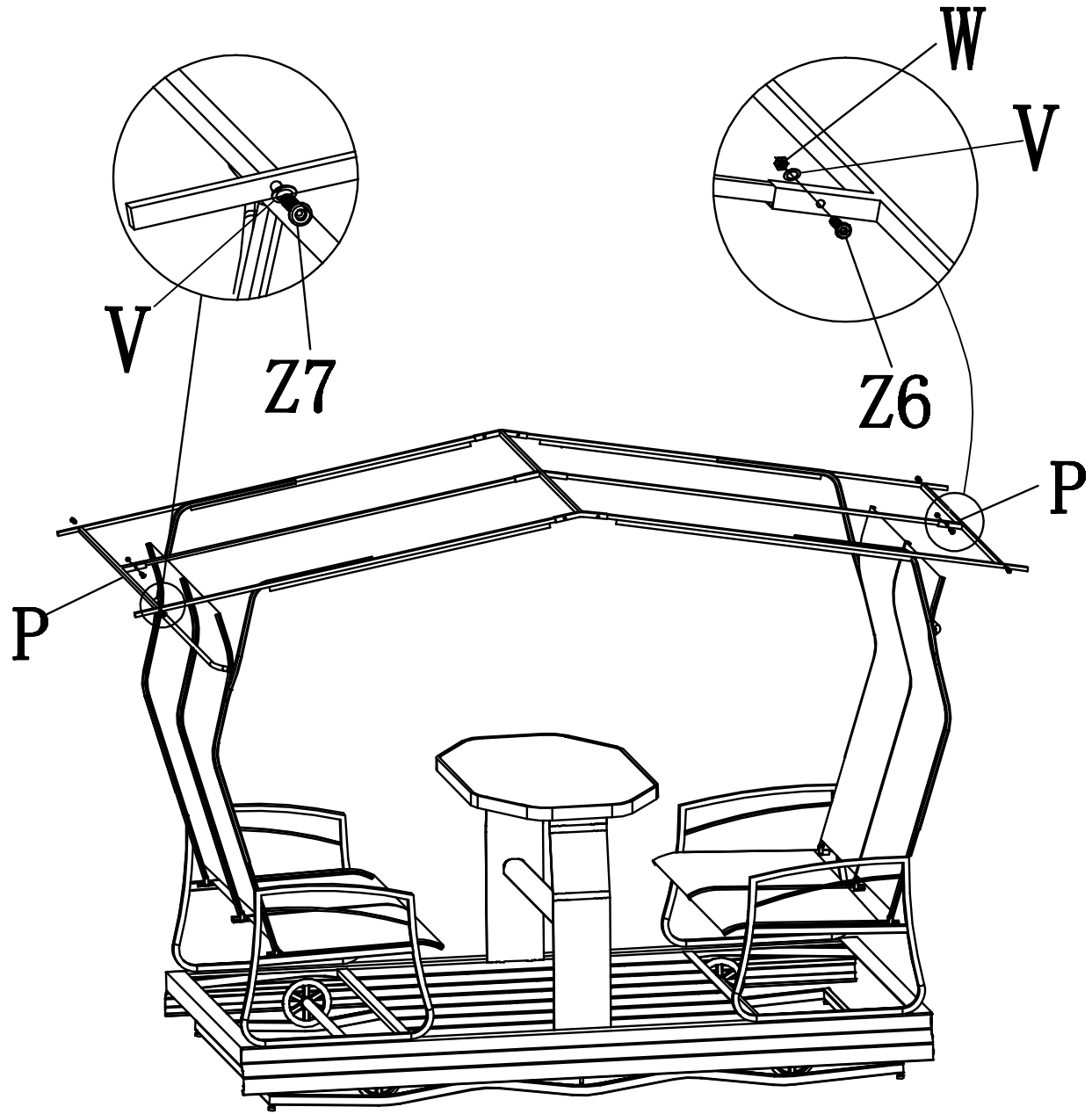

11

PART/PTRCE	FIGURE/DESSIN	QTY/QTEE	PART/PTRCE	FIGURE/DESSIN	QTY/QTEE
P		2	Z6	 M6*35	2
Z7	 M6*25	4	V	 Ø12*Ø6.2X1.0	6
W	 M6	2			



12

PART/PTECE	FIGURE/DESSIN	QTY/QTEE	PART/PTECE	FIGURE/DESSIN	QTY/QTEE
Y2		1	Y5		1

